

# ecoglo® | VISIBLY BETTER 24 HOUR STEP EDGE CONTRAST

Using advanced photoluminescent and non-slip technology Ecoglo products help people negotiate life's hazards.

Installed worldwide, Ecoglo has many raving fans whose patrons are getting safely and easily to where they need to go. Why? Because Ecoglo products are Rough, Tough, Seen and Green!



[www.us.ecoglo.com](http://www.us.ecoglo.com)

## E SERIES

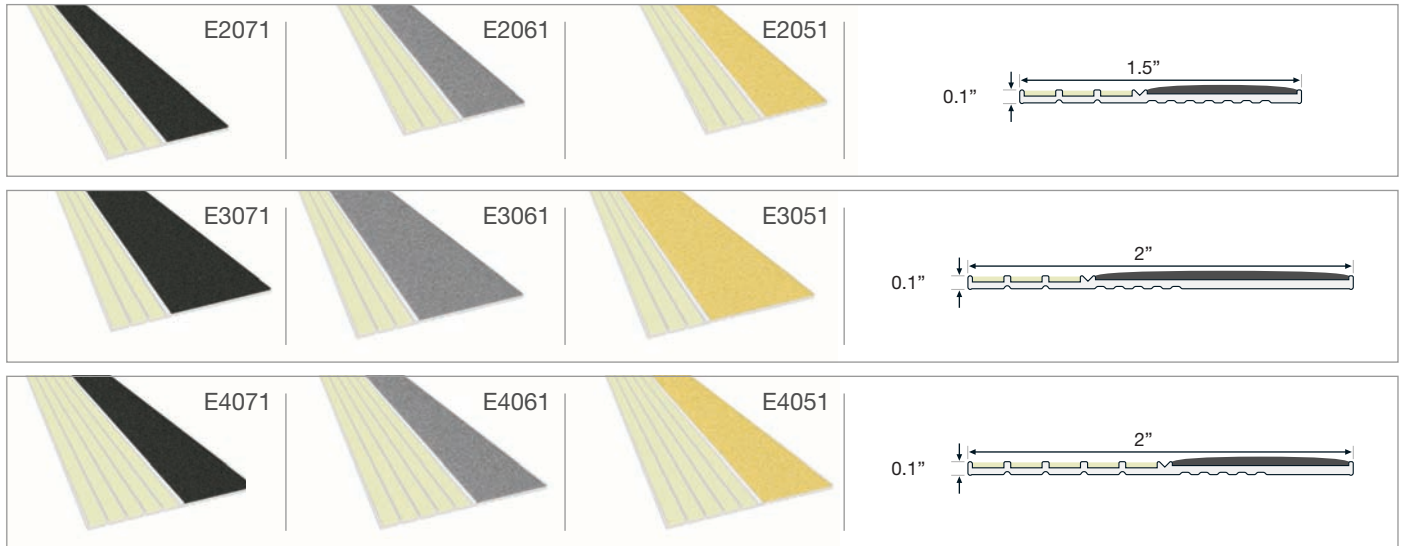

## G SERIES

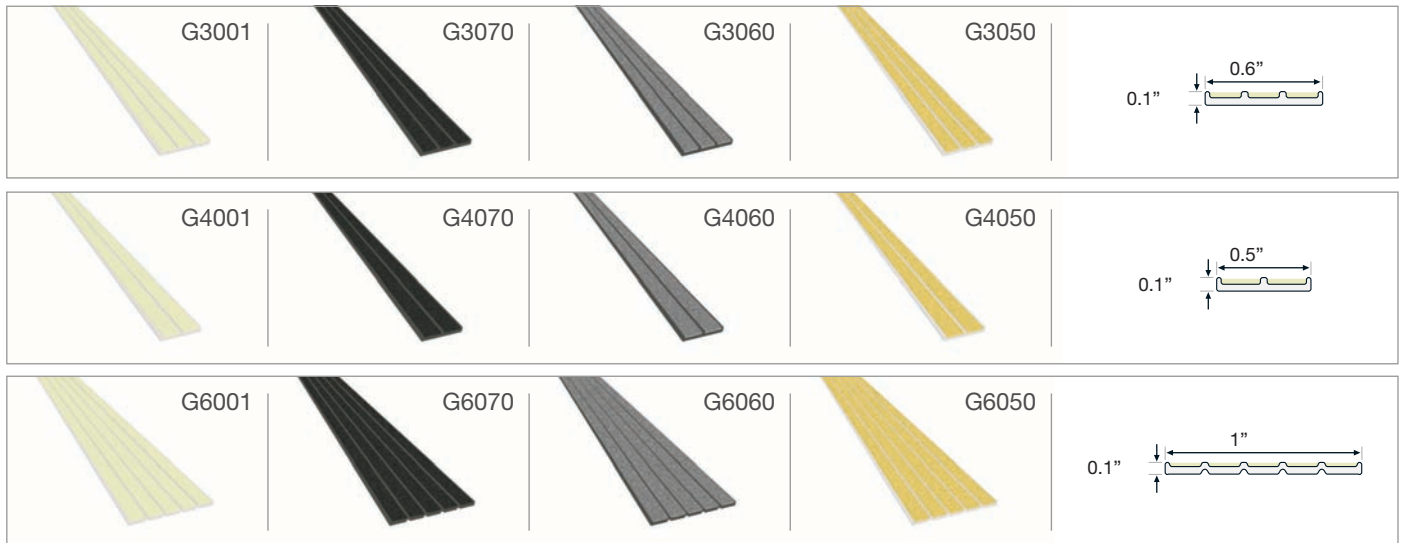

## N SERIES

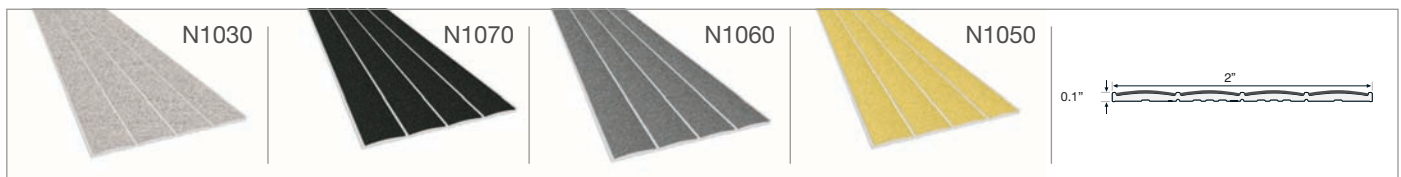

## Carpet to Carpet

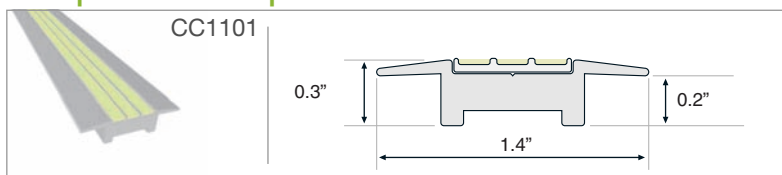

## FLAT NOSINGS



Black Non-Slip - F4171  
 Yellow Non-Slip - F4151  
 Grey Non-Slip - F4161

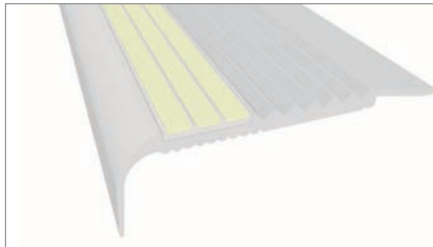
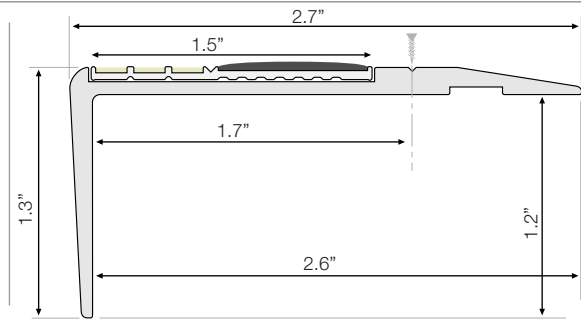

F5101

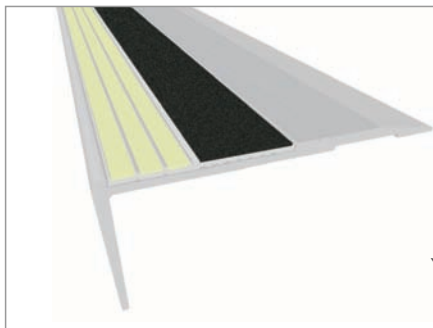
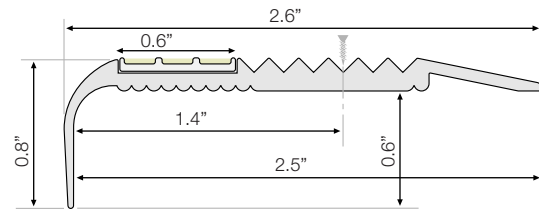

Black Non-Slip - F6171  
 Yellow Non-Slip - F6151  
 Grey Non-Slip - F6161

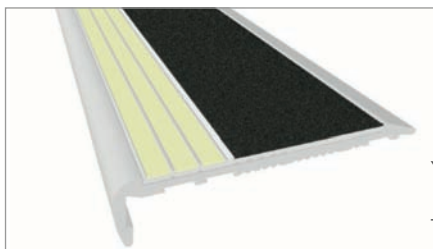
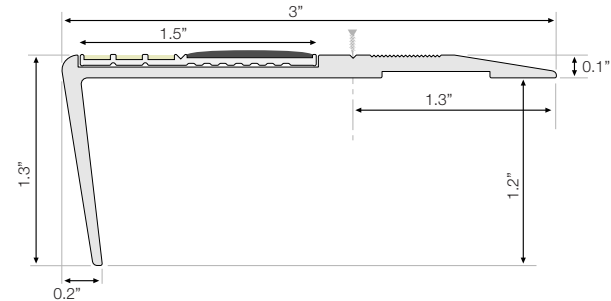

Black Non-Slip - F7171  
 Yellow Non-Slip - F7151  
 Grey Non-Slip - F7161  
 Titania Non-Slip - F7131

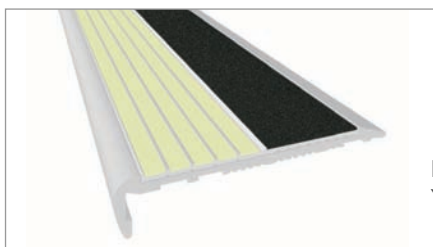
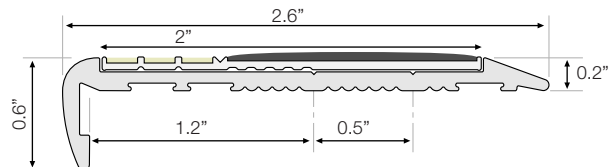

Black Non-Slip - FA7171  
 Yellow Non-Slip - FA7151  
 Grey Non-Slip - FA7161

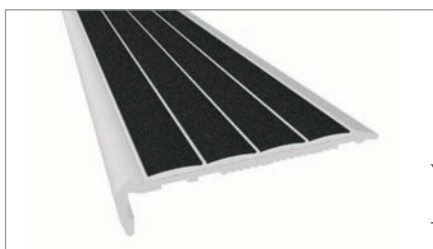
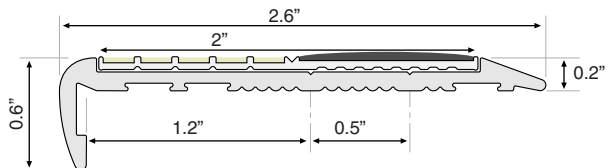

Black Non-Slip - F7170  
 Yellow Non-Slip - F7150  
 Grey Non-Slip - F7160  
 Titania Non-Slip - F7130

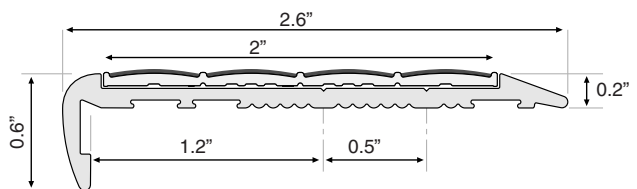

**SIGNAGE**

**EGRESS**

1 7.9" x 3.9"    2 3.9" x 3.9"



Exit EX2010



Emergency Exit Only EE2010

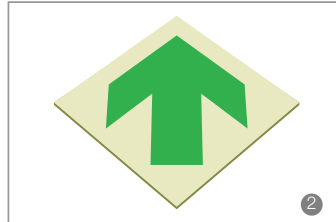

Arrow AR1010H & AR1010D



Running Man RM1010

**EMERGENCY**

2 3.9" x 3.9"



Fire Alarm FA1010



Fire Extinguisher FE1010



Fire Hose FH1010

**AISLE MARKERS**

3 2.6" x 1.8"    4 1.8" x 1.3"    5 3.5" x 3.5"    6 1.5" x 6"    7 2.4" diameter    8 2.7" diameter



RE65/45 & RE45/32.5

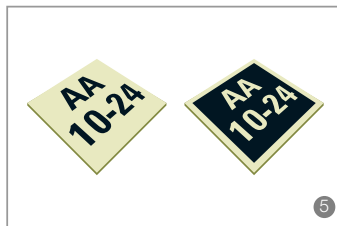

SQ88/88

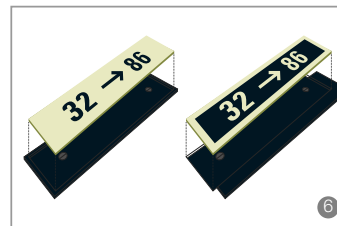

RE38/151 (holder available separately)

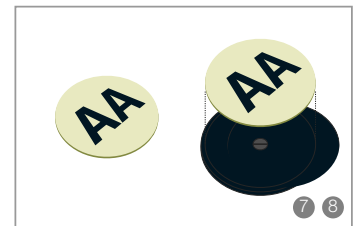

DS60 & DS68 (holder available separately)

**SEAT NUMBERS**

9 1.3" x 1.3"    10 1.6" diameter    11 0.7" x 2.2"    12 0.6" x 1.1"    13 0.6" x 1.8"



SQ31.9r



DS40

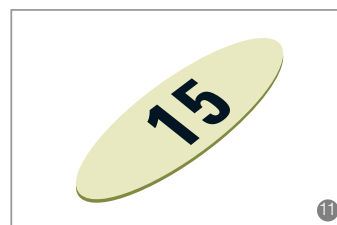

EL18.7/56.7



OR14.7/27.2 & OR16/44.6

**MARKERS**



Hazard Indicator OB82025

**CARPET NOSINGS**



Black Non-Slip - C4171  
 Yellow Non-Slip - C4151  
 Grey Non-Slip - C4161

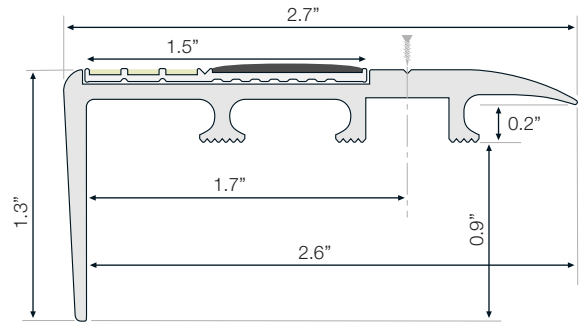

Black Non-Slip - C5171  
 Yellow Non-Slip - C5151  
 Grey Non-Slip - C5161

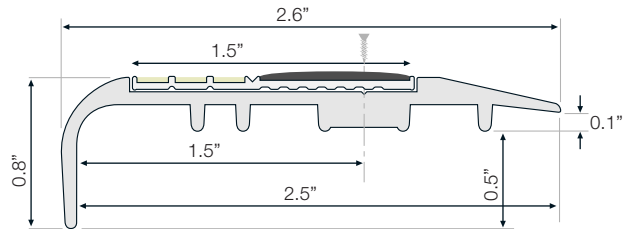

**THRESHOLDS**

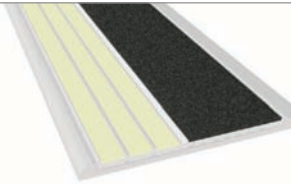

Black Non-Slip - T3171  
 Yellow Non-Slip - T3151  
 Grey Non-Slip - T3161

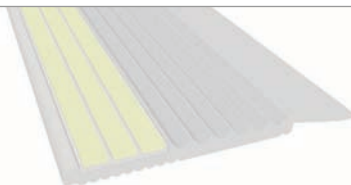
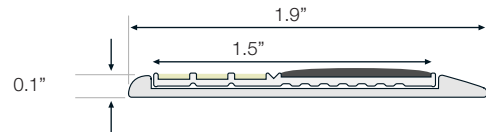

T4101

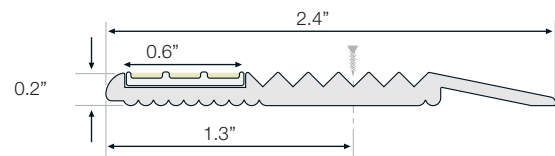

**HANDRAIL STRIPS**

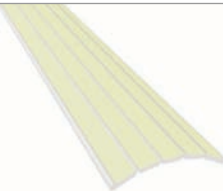

H5001



H3001

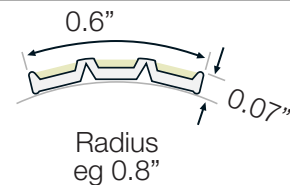

no ecoglo lights on

ecoglo lights on

ecoglo lights off

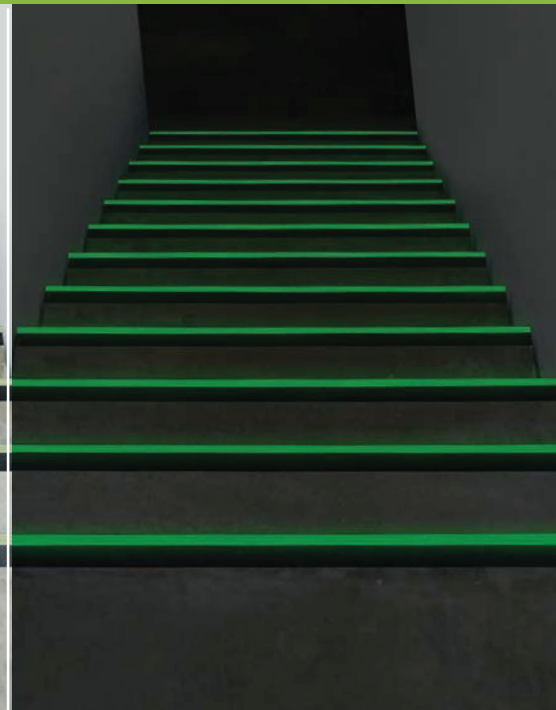
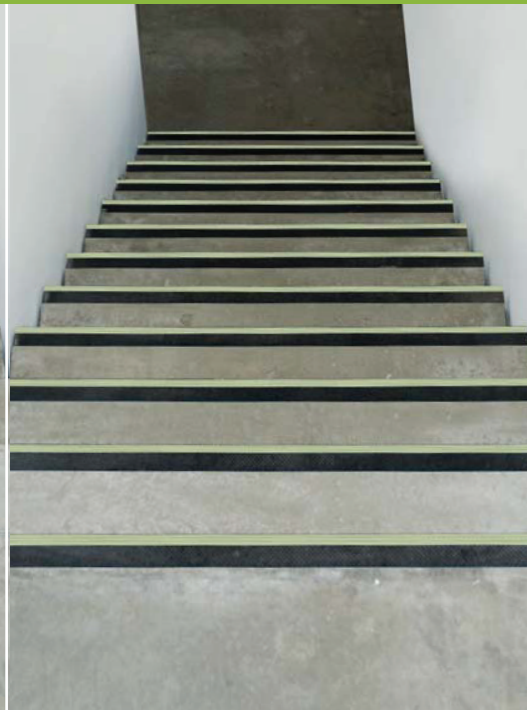

## HOW THE ECOGLO SYSTEM WORKS

Ecoglo uses a patented process to produce a range of products that provide a four pronged solution to pathfinding needs:

- step edge contrast
- slip-resistance
- visibility in all light conditions
- resistance to wear

## ROUGH

The hard-wearing silicon carbide non-slip material is just what you need to reduce slips and falls in all weather conditions. Your patrons will commend you, not complain to you. With their UV resistance and good looks, you can confidently install Ecoglo products inside and out.

## TOUGH

Our patented process bakes in the photoluminescent powder and non-slip material and you get to savor the results. Thousands of people can walk on these products thousands of times with no wear and tear. And just to make sure, we've put them through extensive testing at internationally accredited laboratories relating to durability, weather resistance, UV resistance, stain resistance, abrasion and cleaning. And they passed with flying colors.

## SEEN

Unlike electrical or battery lighting, Ecoglo products will never let you down. They will glow brightly in the dark for many hours giving your patrons confidence in exiting, even in an emergency. Some steps are just too hard to see, whether it be day or night. With Ecoglo, you can be sure your patrons will see the steps, not fall down them, whatever the light conditions. It's the combi-

nation of the photoluminescent strip and the non-slip material that creates such great step edge definition.

## GREEN

Every small step you take to reduce electricity usage helps save our environment. Ecoglo products let you recycle natural sunlight or artificial light. No electricity is required. Ecoglo also goes green by using recycled aluminum. All products are non-toxic and non-radioactive. Designed to last the life of your facility, Ecoglo avoids maintenance costs. Ultimately, Ecoglo is recyclable which avoids the cost of landfill dumping.

ECOGLO STRENGTHS	DELIVER REAL BENEFITS
High quality anti-slip material	Reduces slips and falls
High quality photoluminescence	Visible for hours in dark conditions
Baked in process	Hardwearing, no repainting
Step edge contrast	Reduces falls in light or dark conditions
Recycles natural or artificial light	Decrease electricity usage, increased sustainability
UV resistance	Can be installed inside or out
Internationally accredited testing	Specify with confidence

 | 24 HOUR STEP EDGE CONTRAST



Cert no. SGS-COC-004042  
www.fsc.org  
© 1996 Forest Stewardship Council

**ACCESS PRODUCTS INC.**  
241 Main Street, Suite 100  
Buffalo, New York 14203  
Tel: 888-679-4022  
Fax: 877-679-4192

[www.us.ecoglo.com](http://www.us.ecoglo.com)